

**Instalación**

Superficie de pared o techo.

Diseño

Cuerpo PC/ABS y difusor PC. Luminaria autónoma de emergencia. Incorpora sensor de movimiento y crepuscular. Temperatura de color (CCT) seleccionable. AUTOTEST.

Parte óptica

Difusor opal.

**Installation**

Wall or ceiling surface.

Design

PC/ABS body and PC diffuser. Self contained luminaire. It incorporates a motion and twilight sensor. Color temperature (CCT) selectable. SELF-TEST.

Optical part

Opal diffuser.





E-SENSE SLIM CCT

IP54

Iluminación de emergencia
Emergency lighting







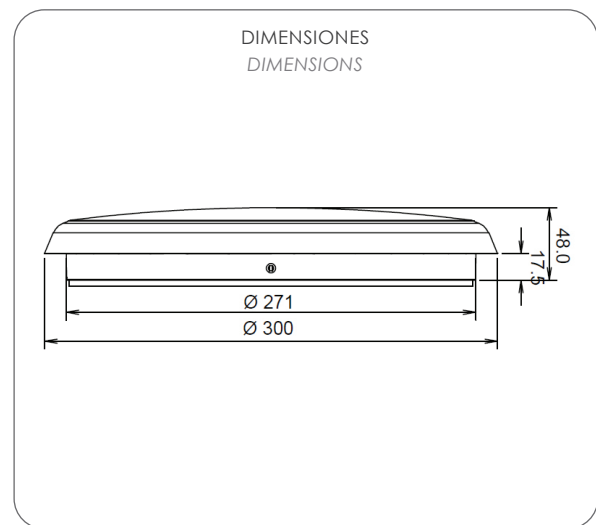
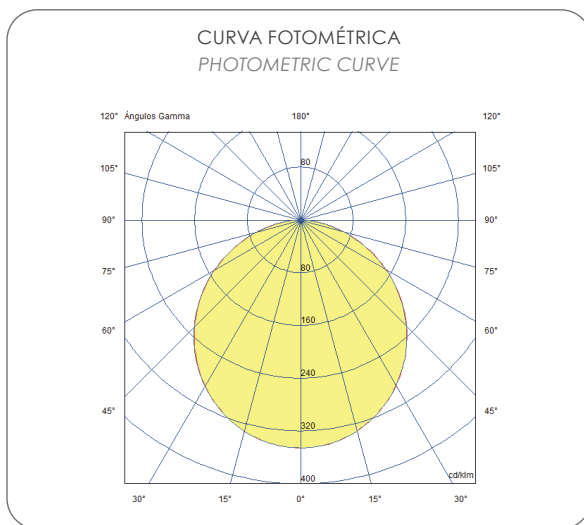

ESPECIFICACIONES SPECIFICATIONS

-  200-240V ~ 50/60Hz
-  IP54/IK10
-  Seleccionable 3000K - 4000K - 5700K
Selectable 3000K - 4000K - 5700K
-  Permanente*/No permanente/Autotest
Maintained*/Non maintained/Self-test
-  Sensor de microondas ajustable con switch
Microwave adjustable sensor with slide switch

-  Clase II
Class II
-  Marcado CE
CE marked
-  Garantía 3 años
3 year warranty
-  24 horas
24 hours
-  LiFePO4



Código Code	Modelo Model								
800007CCT	E-SENSE SLIM 25 SENSOR/EMERGENCY CCT	<input type="checkbox"/>	<input type="checkbox"/>	NP/AT	54	1.40	3	250	6.4V 1.5Ah
800007CCTE*	E-SENSE SLIM 25 EMERGENCY/ON-OFF CCT	<input type="checkbox"/>	<input type="checkbox"/>	P/NP/AT	54	1.40	3	250	6.4V 1.5Ah

*No dispone de opción sensor/ It does not have a sensor option

Fabricado según la norma UNE-EN 60598-2-22/Manufactured according to standard UNE-EN 60598-2-22